

# 2SA1859/1859A

Silicon PNP Epitaxial Planar Transistor (Complement to type 2SC4883/A)

Application : Audio Output Driver and TV Velocity-modulation

■ Absolute maximum ratings (Ta=25°C)

Symbol	Ratings		Unit
	2SA1859	2SA1859A	
V <sub>CB0</sub>	-150	-180	V
V <sub>CE0</sub>	-150	-180	V
V <sub>EB0</sub>	-6		V
I <sub>c</sub>	-2		A
I <sub>b</sub>	-1		A
P <sub>c</sub>	20(T <sub>c</sub> =25°C)		W
T <sub>j</sub>	150		°C
T <sub>stg</sub>	-55 to +150		°C

■ Electrical Characteristics (Ta=25°C)

Symbol	Conditions	Ratings		Unit
		2SA1859	2SA1859A	
I <sub>cB0</sub>	V <sub>CB</sub> =	-10max		μA
I <sub>eB0</sub>	V <sub>EB</sub> =-6V	-150	-180	V
I <sub>eB0</sub>		-10max		μA
V <sub>(BR)CEO</sub>	I <sub>c</sub> =-10mA	-150min	-180min	V
h <sub>FE</sub>	V <sub>CE</sub> =-10V, I <sub>c</sub> =-0.7A	60 to 240		
V <sub>CE(sat)</sub>	I <sub>c</sub> =-0.7A, I <sub>b</sub> =-70mA	-1.0max		V
f <sub>r</sub>	V <sub>CE</sub> =-12V, I <sub>e</sub> =0.7A	60typ		MHz
COB	V <sub>CB</sub> =-10V, f=1MHz	30typ		pF

■ Typical Switching Characteristics (Common Emitter)

V <sub>CC</sub> (V)	R <sub>L</sub> (Ω)	I <sub>c</sub> (A)	V <sub>BB1</sub> (V)	V <sub>BB2</sub> (V)	I <sub>B1</sub> (mA)	I <sub>B2</sub> (mA)	t <sub>on</sub> (μs)	t <sub>stg</sub> (μs)	t <sub>f</sub> (μs)
-20	20	-1	-10	5	-100	100	0.5typ	1.0typ	0.5typ

External Dimensions FM20(TO220F)

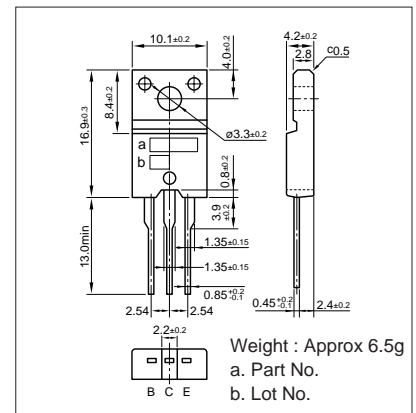

I<sub>c</sub>-V<sub>CE</sub> Characteristics (Typical)

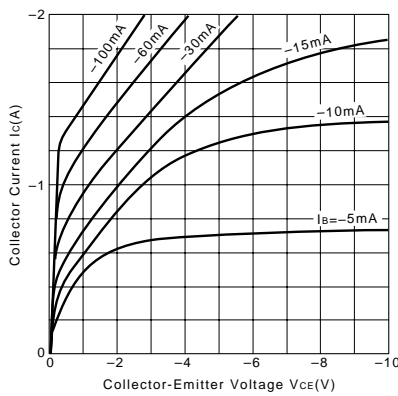

V<sub>CE(sat)</sub>-I<sub>b</sub> Characteristics (Typical)

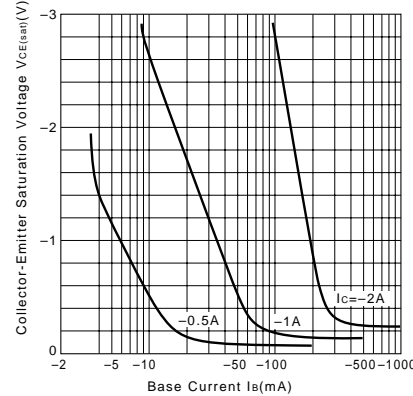

I<sub>c</sub>-V<sub>BE</sub> Temperature Characteristics (Typical)

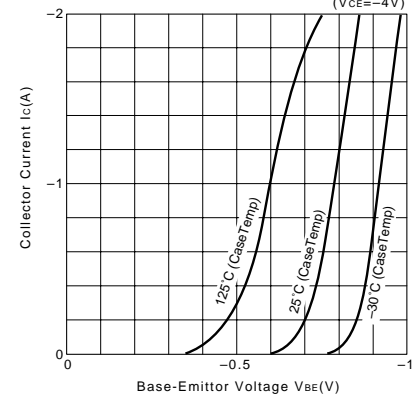

h<sub>FE</sub>-I<sub>c</sub> Characteristics (Typical)

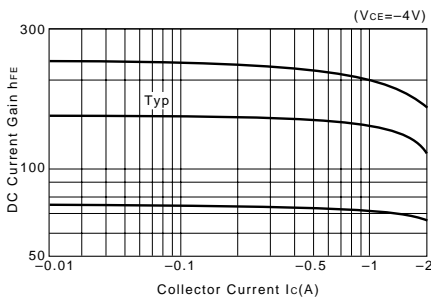

h<sub>FE</sub>-I<sub>c</sub> Temperature Characteristics (Typical)

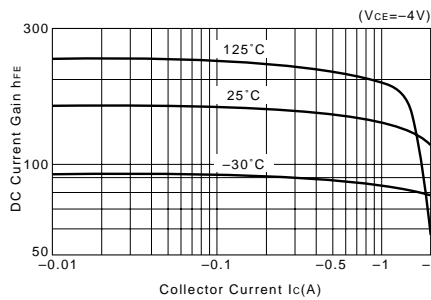

θ<sub>j-a</sub>-t Characteristics

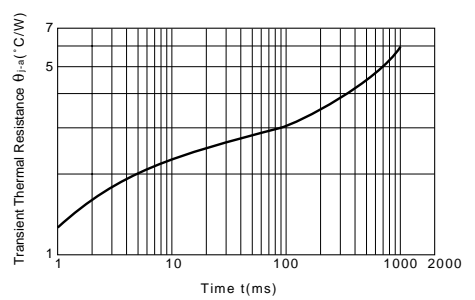

f<sub>r</sub>-I<sub>e</sub> Characteristics (Typical)

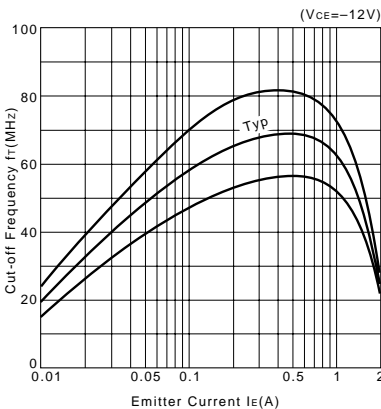

Safe Operating Area (Single Pulse)

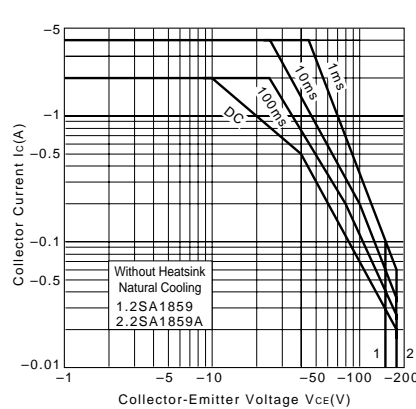

P<sub>c</sub>-T<sub>a</sub> Derating

