

# 2SC4883/4883A

Silicon NPN Epitaxial Planar Transistor (Complement to type 2SA1859/A)

Application : Audio Output Driver and TV Velocity-modulation

■ Absolute maximum ratings (Ta=25°C)

Symbol	Ratings		Unit
	2SC4883	2SC4883A	
VcBO	150	180	V
VcEO	150	180	V
VEBO	6		V
Ic	2		A
Ib	1		A
Pc	20(Tc=25°C)		W
Tj	150		°C
Tstg	-55 to +150		°C

■ Electrical Characteristics (Ta=25°C)

Symbol	Conditions	Ratings		Unit
		2SC4883	2SC4883A	
IcBO	Vcb=	150	180	μA
IcBO	Vcb=	10max		μA
IcBO	Vcb=	150	180	V
IcBO	Vcb=	10max		μA
V(BR)CEO	Ic=10mA	150min	180min	V
hFE	VCE=10V, Ic=0.7A	60 to 240		
VCE(sat)	Ic=0.7A, Ib=70mA	1.0max		V
fr	VCE=12V, IE=-0.7A	120typ		MHz
COB	Vcb=10V, f=1MHz	30typ		pF

■ Typical Switching Characteristics (Common Emitter)

VCC (V)	RL (Ω)	Ic (A)	VBB1 (V)	VBB2 (V)	Ib1 (mA)	Ib2 (mA)	ton (μs)	tstg (μs)	tr (μs)
20	20	1	10	-5	100	-100	0.5typ	1.5typ	0.5typ

External Dimensions FM20(TO220F)

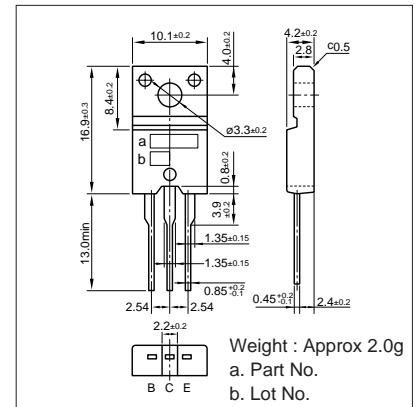

Ic-VCE Characteristics (Typical)

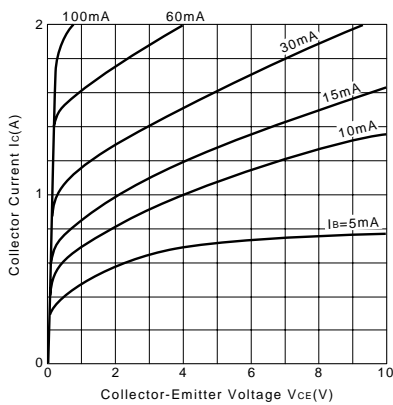

VCE(sat)-Ib Characteristics (Typical)

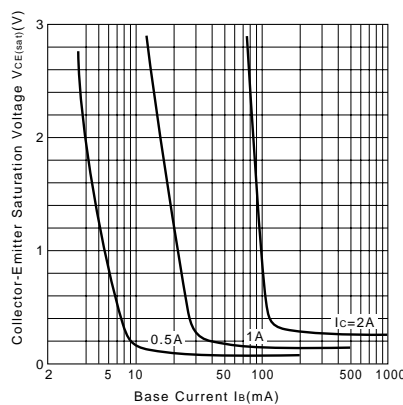

Ic-VBE Temperature Characteristics (Typical)

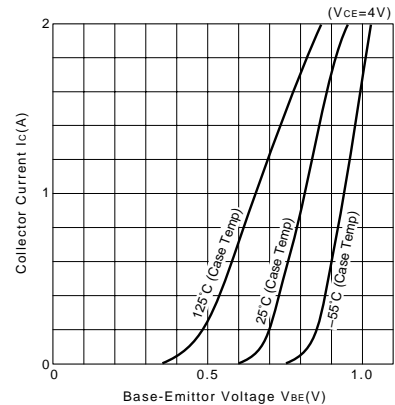

hFE-Ic Characteristics (Typical)

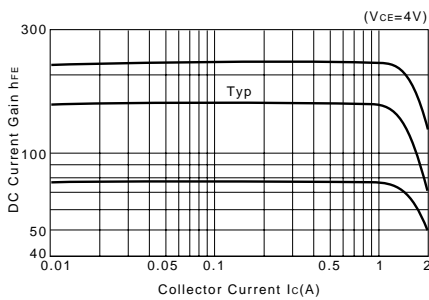

hFE-Ic Temperature Characteristics (Typical)

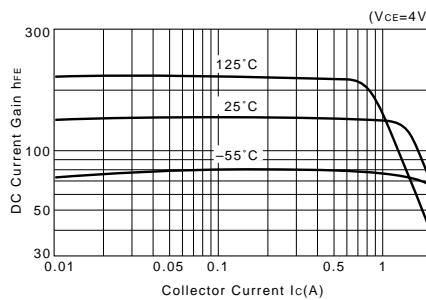

θj-a-t Characteristics

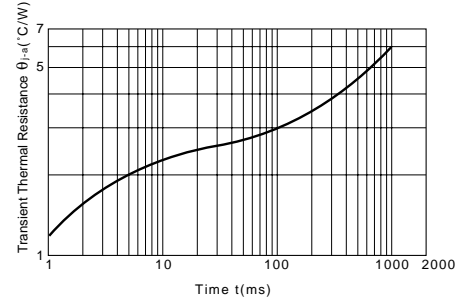

fr-IE Characteristics (Typical)

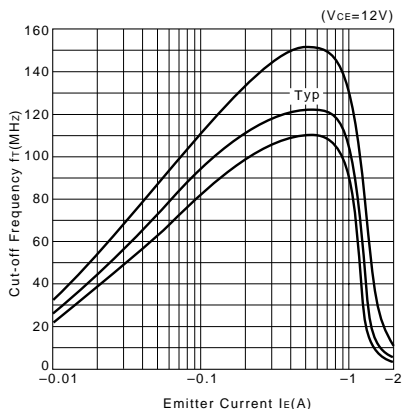

Safe Operating Area (Single Pulse)

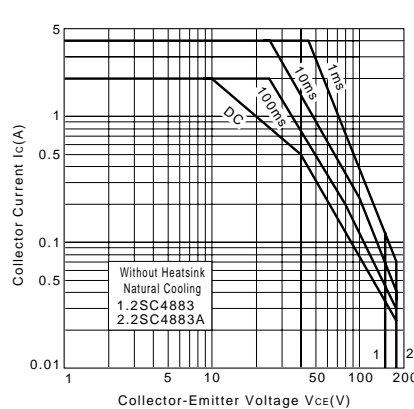

Pc-Ta Derating

