



# LA1600

## 1-Band AM Radio

### Overview

The LA1600, being an AM tuner IC placed in a 9-pin SIP, provides the functions of an AM tuner. It is usable in the band range up to SW band and is especially suited for use in low-cost AM radios and radio-controlled receivers.

### Functions

- AM : RF amp, MIX, OSC, IF amp, detector, AGC.

### Features

- Minimum number of external parts required.
- Low current drain (3.7mA).
- Low supply voltage (1.8V min).
- Adoption of double-balanced mixer.
- Usable in the band range up to SW band.

### Package Dimensions

unit : mm

#### 3017B-SIP9

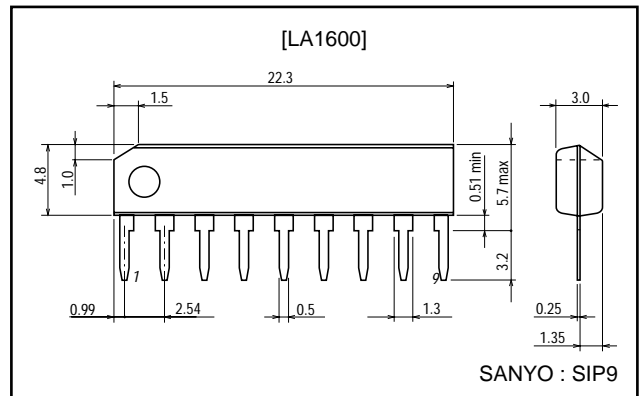

### Specifications

**Maximum Ratings** at Ta=25°C, See specified Test Circuit.

Parameter	Symbol	Conditions	Ratings	Unit
Maximum supply voltage	V <sub>CC</sub> max	Pin 3	9	V
		Pin 4	9	V
		Pin 8	7	V
Allowable power dissipation	P <sub>d</sub> max	Ta≤70°C	100	mW
Operating temperature	T <sub>opr</sub>		-20 to +70	°C
Storage temperature	T <sub>stg</sub>		-40 to +125	°C

### Operating Conditions

at Ta=25°C

Parameter	Symbol	Conditions	Ratings	Unit
Recommended operating voltage	V <sub>CC</sub>		3	V
Operating voltage range	V <sub>CC</sub> op		1.8 to 6.0	V

### Operating Characteristics

at Ta=25°C, V<sub>CC</sub>=3V, See specified Test Circuit.

Parameter	Symbol	Conditions	Ratings			Unit
			min	typ	max	
[AM Characteristics/f=1MHz]						
Quiescent current	I <sub>cco</sub>	V <sub>IN</sub> =No input		3.7	4.6	mA
Detection output	V <sub>O1</sub>	V <sub>IN</sub> =23dBμ, 1kHz-30% mod	-30	-25	-20	dBm
			24	43	78	mV
	V <sub>O2</sub>	V <sub>IN</sub> =80dBμ, 1kHz-30% mod	-18	-14	-10	dBm
			97	155	250	mV
S/N	S/N1	V <sub>IN</sub> =23dBμ	18	21.5		dB
	S/N2	V <sub>IN</sub> =80dBμ	48	53		dB
Total harmonic distortion	THD1	V <sub>IN</sub> =80dBμ, 1kHz-30% mod		0.3	1.2	%
	THD2	V <sub>IN</sub> =100dBμ, 1kHz-30% mod		0.4	1.5	%

# LA1600

## Equivalent Circuit Block Diagram

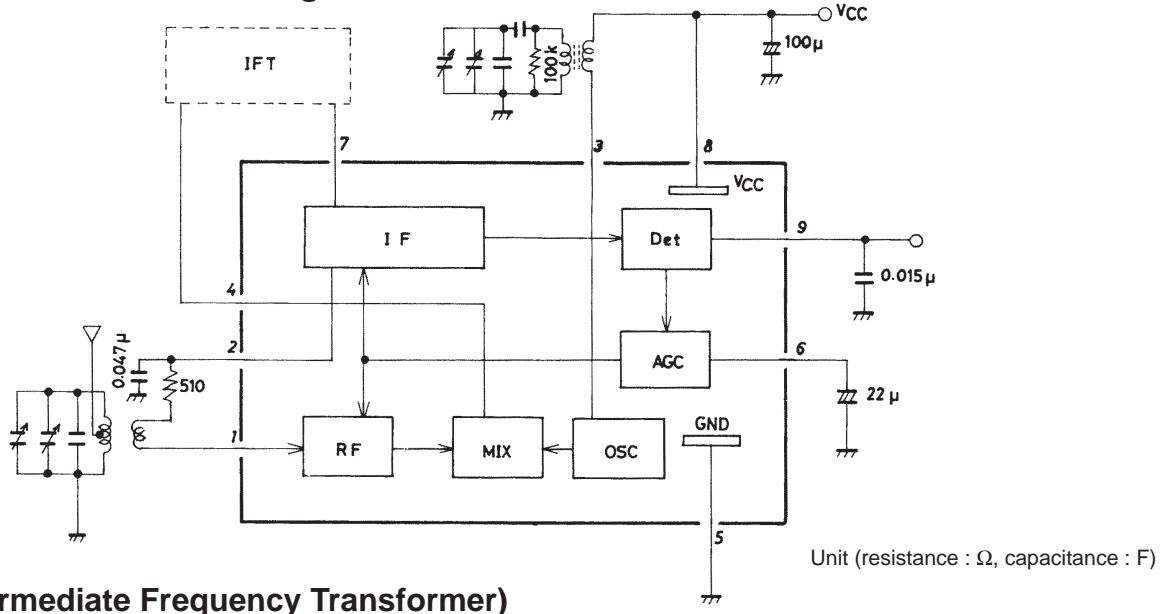

## IFT (Intermediate Frequency Transformer)

1. Using double tuning coil

2. Using ceramic filter

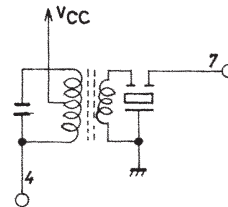
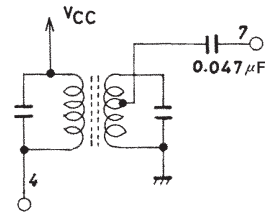

## Specified Test Circuit Diagram

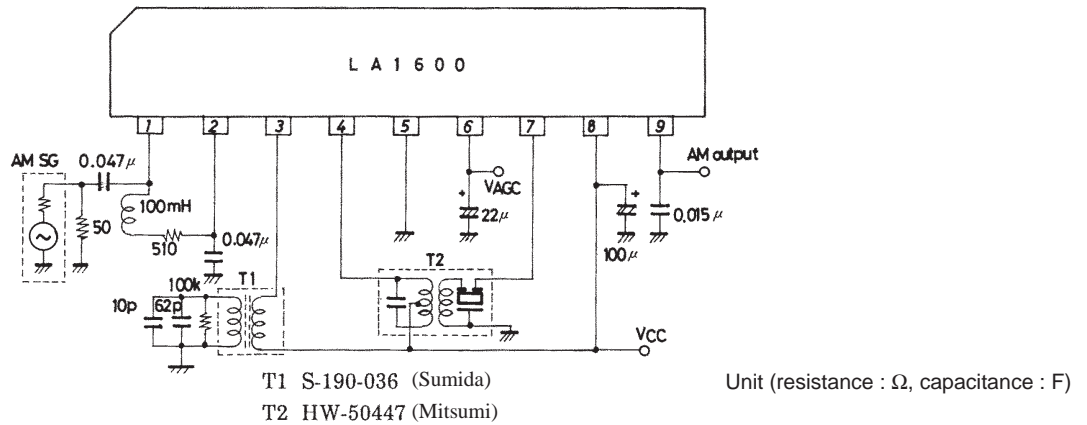

## Test Circuit 1 : AM-MW

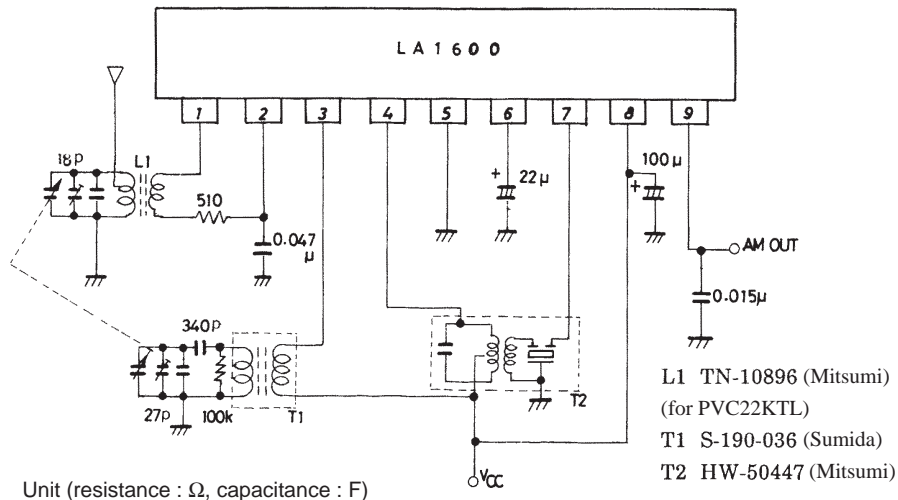

# LA1600

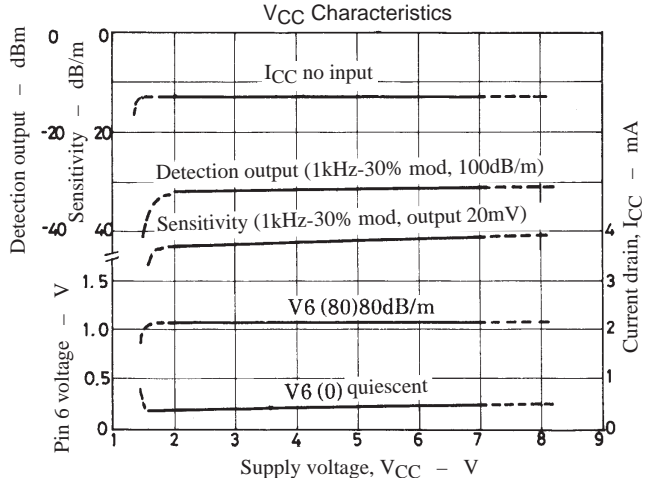
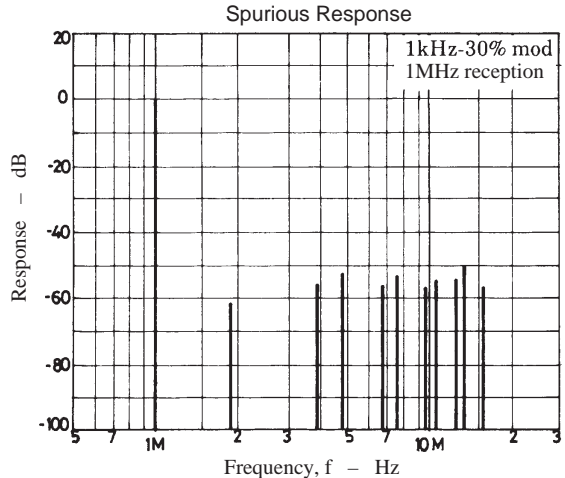
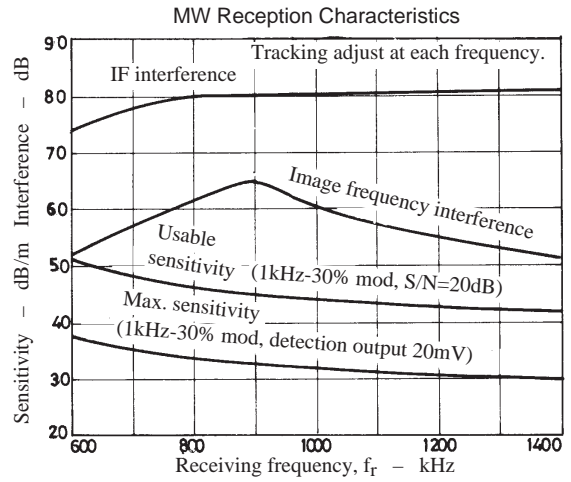
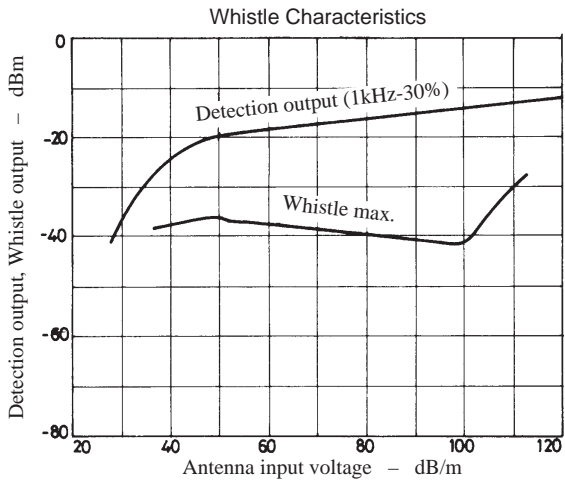
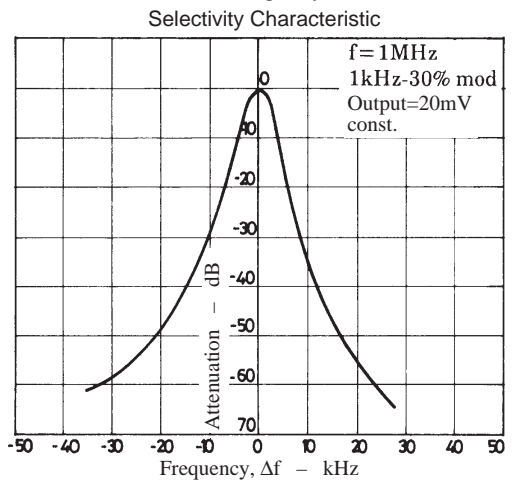
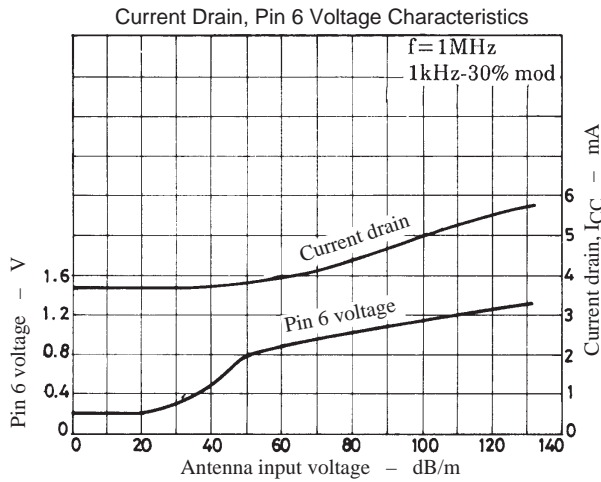
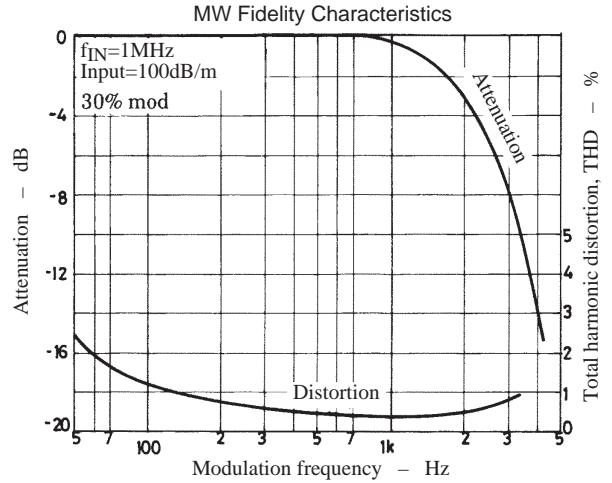
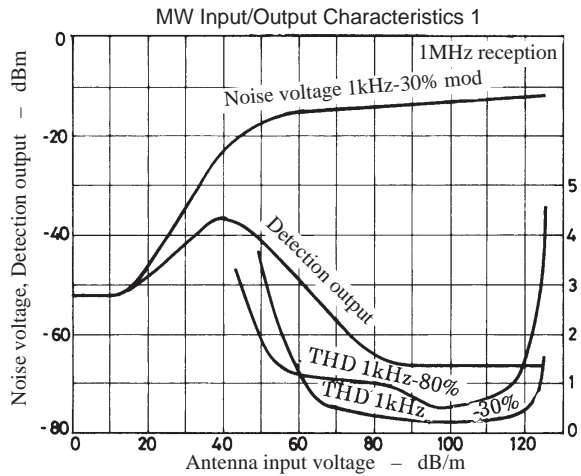

# LA1600

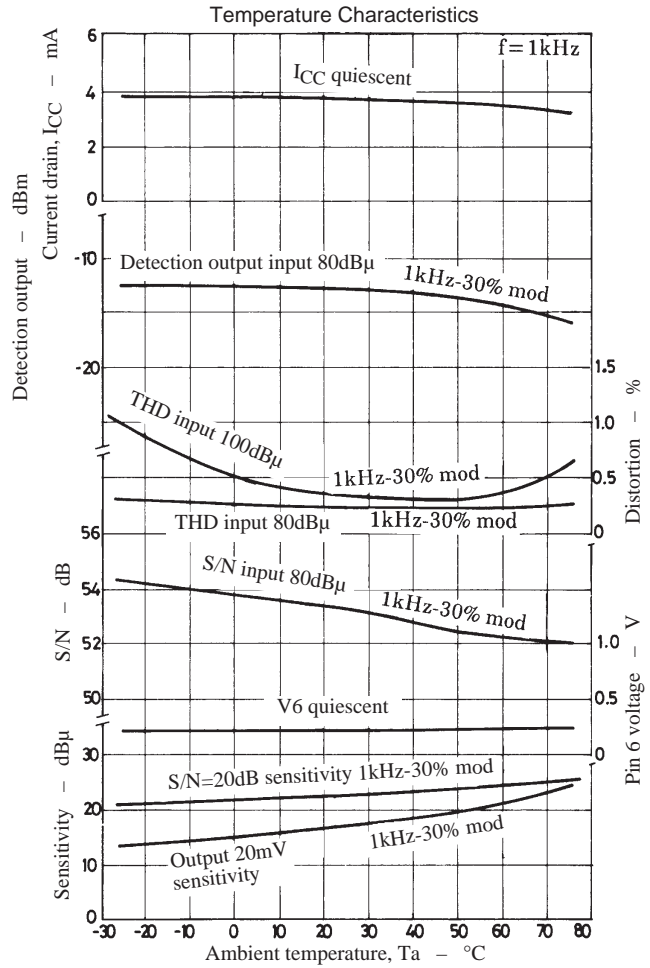

## Test Circuit 2 : AM-MW

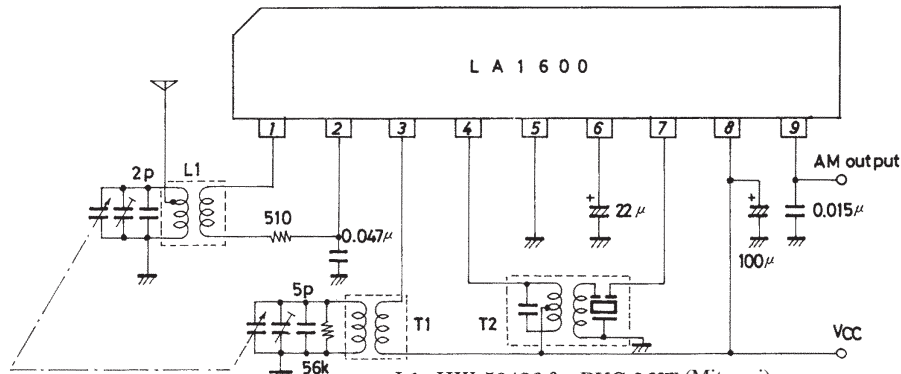

L1 : HW-50426 for PVC-LYT (Mitsumi)

T1 : HW-50425 (Mitsumi)

T2 : HW-50447 (Mitsumi)

Unit (resistance : Ω, capacitance : F)

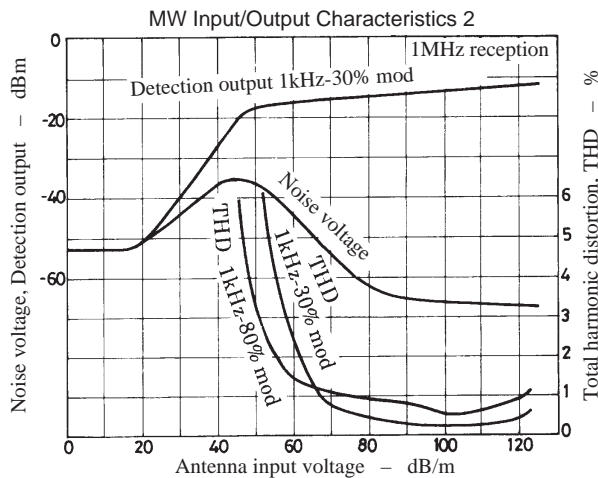

# LA1600

## Test Circuit 3 : SW2 (7.2 to 24.0MHz)

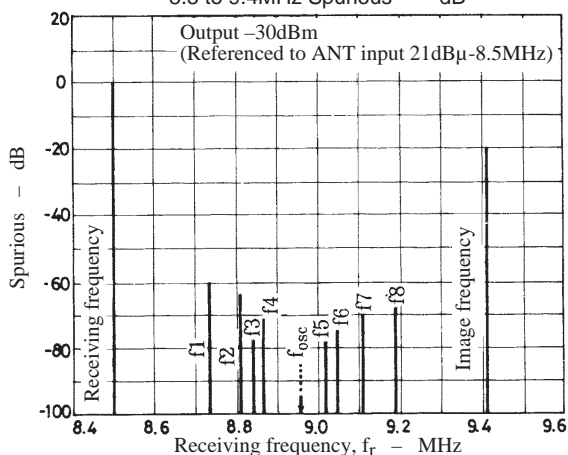
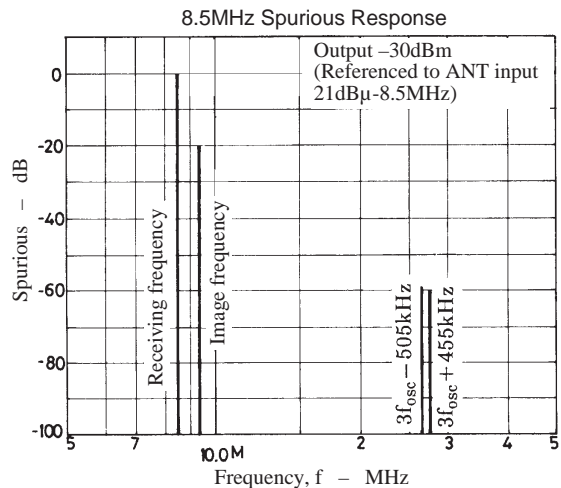
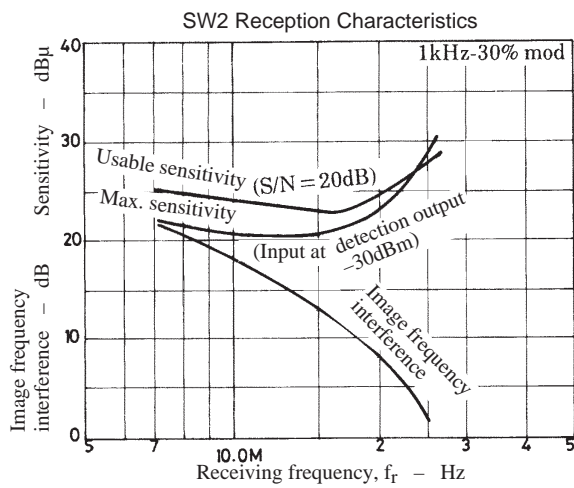
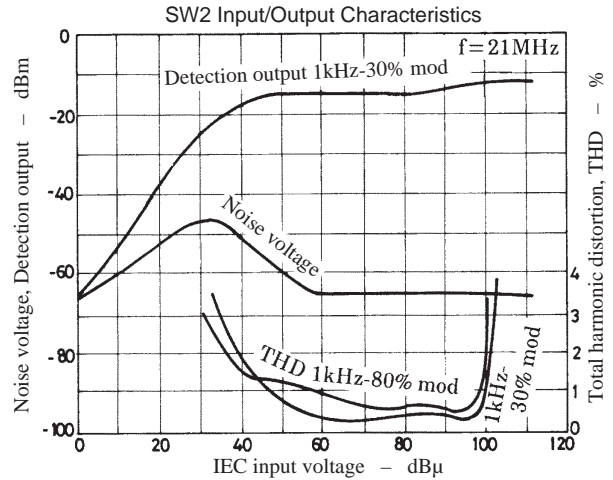
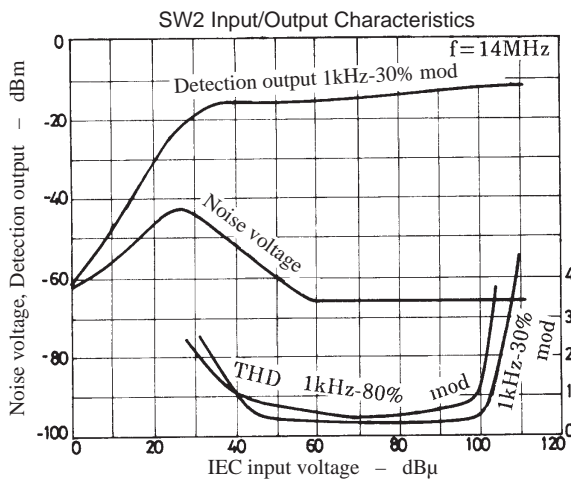
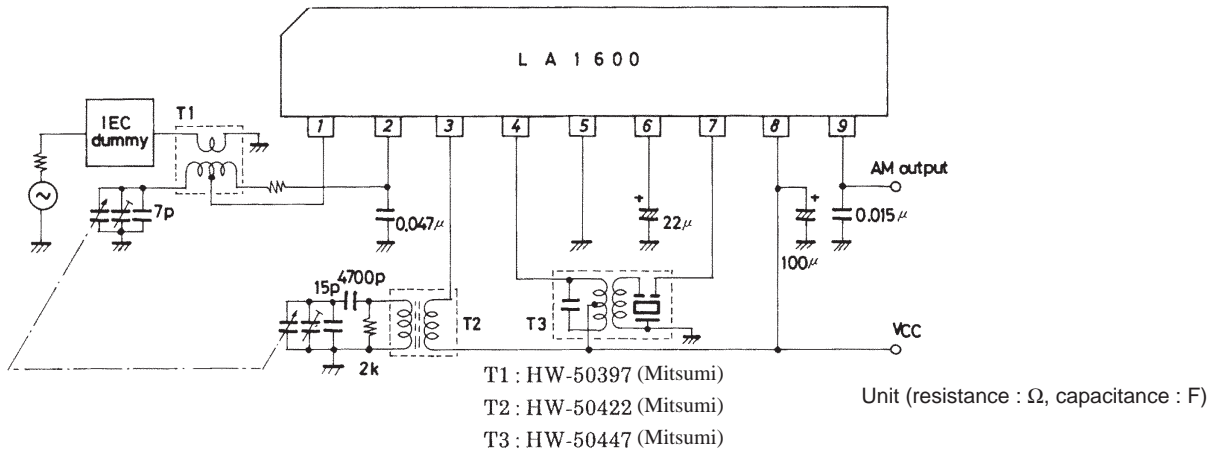

- f1 : 8.7336MHz → 2f<sub>OSC</sub>-2f1 = 455kHz
- f2 : 8.8097MHz → 3f<sub>OSC</sub>-3f2 = 455kHz
- f3 : 8.8478MHz → 4f<sub>OSC</sub>-4f3 = 455kHz
- f4 : 8.8702MHz → 5f<sub>OSC</sub>-5f4 = 455kHz
- f5 : 9.0263MHz → 5f5-5f<sub>OSC</sub> = 455kHz
- f6 : 9.0525MHz → 4f6-4f<sub>OSC</sub> = 455kHz
- f7 : 9.1130MHz → 3f7-3f<sub>OSC</sub> = 455kHz
- f8 : 9.1888MHz → 2f8-2f<sub>OSC</sub> = 455kHz

**Coil Specifications**

MW antenna

Bar antenna (for PVC22KTL)

- TN-10896 (Mitsumi)

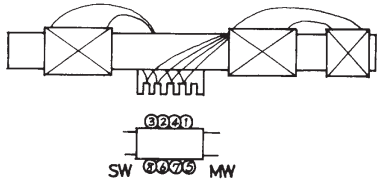

- ①-② 22T + 49T, ③-④ 10T  
Tight solenoid direct winding
- ⑤-⑥ 17T 0.5φ space winding
- ⑦-⑧ 4T tight solenoid winding
- ①-② L = 260μH, Q<sub>0</sub> = 330 (≥ 200)
- ⑤-⑥ L = 15μH, Q<sub>0</sub> = 250 (≥ 150)

Bar antenna (for PVC-LYT)

- HW-50426 (Mitsumi)

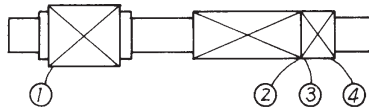

- ①-② 21T + 100T
- ③-④ 30T
- ①-② L = 604μH, Q<sub>0</sub> ≥ 120

MW OSC

- S-190-036 (Sumida)

For PVC22KTL

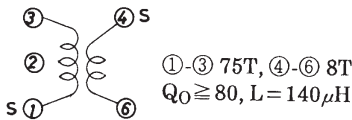

- ①-③ 75T, ④-⑥ 8T
- Q<sub>0</sub> ≥ 80, L = 140μH

- HW-50426 (Mitsumi)

For PVC-LYT

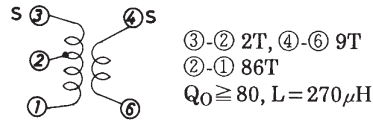

- ③-② 2T, ④-⑥ 9T
- ②-① 86T
- Q<sub>0</sub> ≥ 80, L = 270μH

AM-IFT

- HW-50447 (Mitsumi)

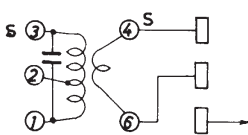

- ①-② 82T, ③-② 70T,
- ④-⑥ 7T
- Q<sub>0</sub> = 110 ± 20%, f = 450kHz
- Internal 180pF
- C.F: SFU450B

AM-IFT

Application where a double tuning coil is used

HW-50475

HW-50498

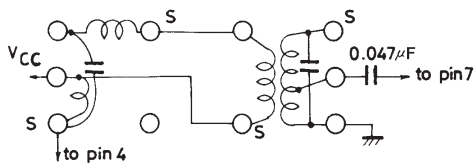

HW-50475  
(Mitsumi)

- ①-② 80T
- ④-③ 70 1/2T
- Internal 180pF
- Q<sub>0</sub> = 120 ± 20%

HW-50498  
(Mitsumi)

- ①-② 134T
- ④-⑥ 3T
- ②-③ 18T
- Internal 180pF
- Q<sub>0</sub> = 70 ± 20%

**Sample Application Circuit 1**

Earphone

Transistor rank=G280 to 560

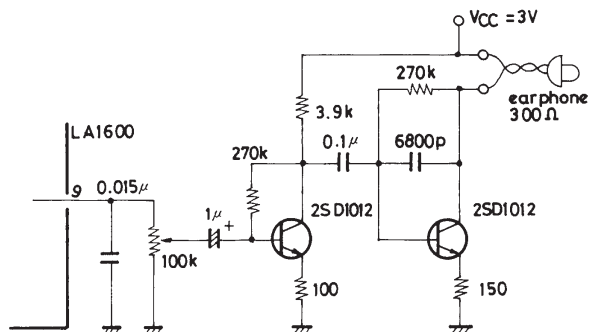

**Sample Application Circuit 2**

Power amp using 3 discrete devices

Transistor rank=E100 to 200

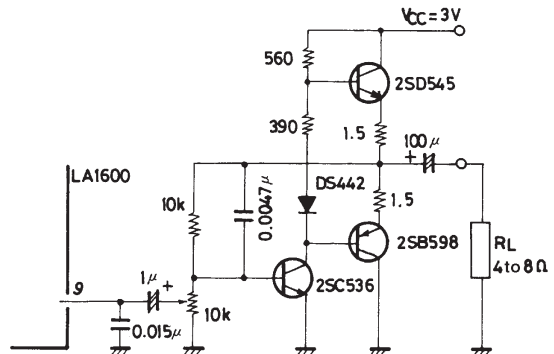

Unit (resistance : Ω, capacitance : F)

# LA1600

## Sample Application Circuit 3

Using the LA4510

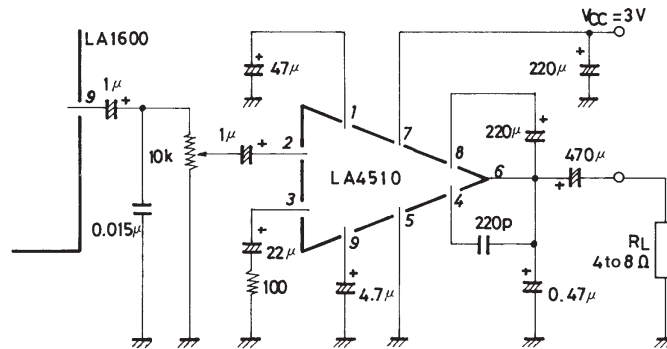

Unit (resistance : Ω, capacitance : F)

## Sample Printed Circuit Pattern : LA1600 + Power amp using 3 discrete devices

(For the circuit diagram, refer to Test Circuit 2 and Sample Application Circuit 2.)

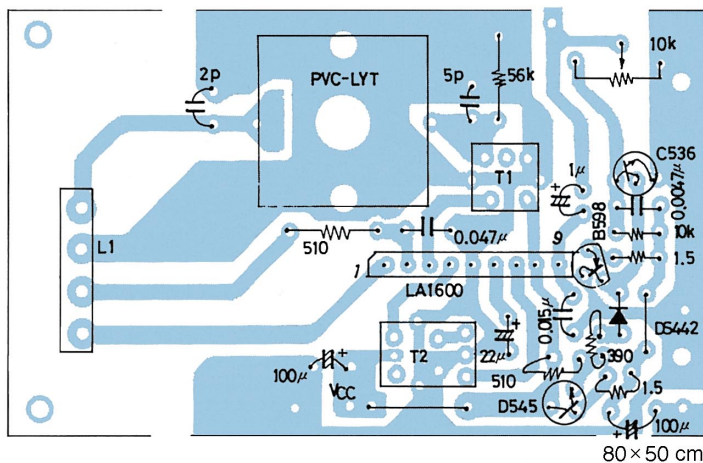

L1 : HW-50426 (Mitsumi)  
L1 : HW-50425 (Mitsumi)  
T2 : HW-50447 (Mitsumi)

- No products described or contained herein are intended for use in surgical implants, life-support systems, aerospace equipment, nuclear power control systems, vehicles, disaster/crime-prevention equipment and the like, the failure of which may directly or indirectly cause injury, death or property loss.
- Anyone purchasing any products described or contained herein for an above-mentioned use shall:
  - ① Accept full responsibility and indemnify and defend SANYO ELECTRIC CO., LTD., its affiliates, subsidiaries and distributors and all their officers and employees, jointly and severally, against any and all claims and litigation and all damages, cost and expenses associated with such use:
  - ② Not impose any responsibility for any fault or negligence which may be cited in any such claim or litigation on SANYO ELECTRIC CO., LTD., its affiliates, subsidiaries and distributors or any of their officers and employees jointly or severally.
- Information (including circuit diagrams and circuit parameters) herein is for example only; it is not guaranteed for volume production. SANYO believes information herein is accurate and reliable, but no guarantees are made or implied regarding its use or any infringements of intellectual property rights or other rights of third parties.

This catalog provides information as of December, 1997. Specifications and information herein are subject to change without notice.