

TOSHIBA BIPOLAR LINEAR INTEGRATED CIRCUIT SILICON MONOLITHIC

TA7358AP

FM FRONT-END

The TA7358AP is designed for a FM front-end application, which is suitable to a portable radio or a radio cassette.

Comparing with conventional types, supply voltage dependence, overload characteristics and spurious radiation characteristics are improved.

FEATURES

- Wide supply voltage range : $V_{CC} = 1.6 \sim 6.0V$
- Excellent supply voltage dependence of local oscillator : Oscillation stop $V_{CC} = 0.9V$ (Typ.)
- Improved inter-modulation characteristics by double balanced type mixer circuit.
- Low spurious radiation.
- Built-in clamping diode for the local oscillator output.

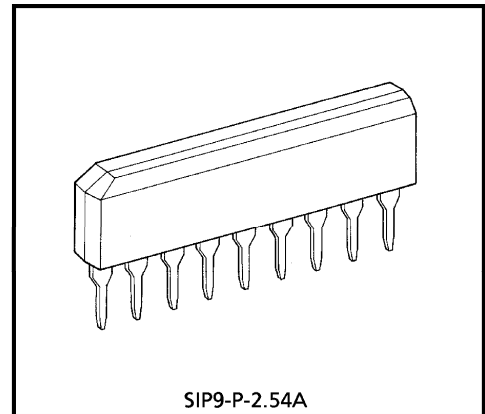

SIP9-P-2.54A
Weight : 0.92g (Typ.)

BLOCK DIAGRAM

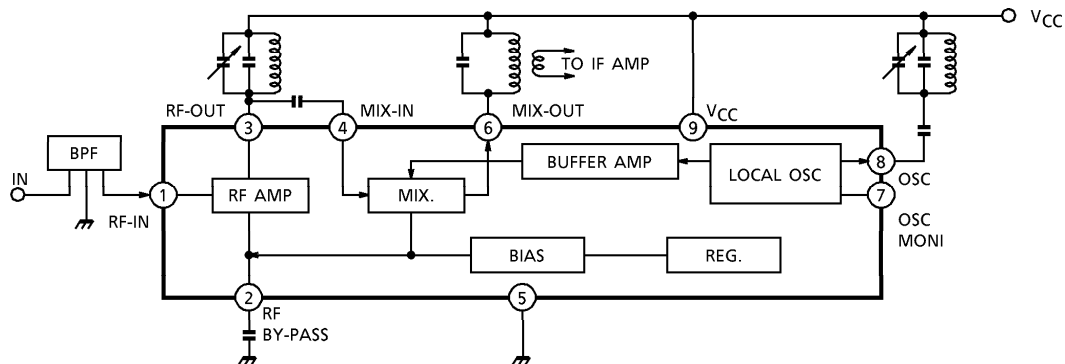

961001EBA2

- TOSHIBA is continually working to improve the quality and the reliability of its products. Nevertheless, semiconductor devices in general can malfunction or fail due to their inherent electrical sensitivity and vulnerability to physical stress. It is the responsibility of the buyer, when utilizing TOSHIBA products, to observe standards of safety, and to avoid situations in which a malfunction or failure of a TOSHIBA product could cause loss of human life, bodily injury or damage to property. In developing your designs, please ensure that TOSHIBA products are used within specified operating ranges as set forth in the most recent products specifications. Also, please keep in mind the precautions and conditions set forth in the TOSHIBA Semiconductor Reliability Handbook.
- The products described in this document are subject to foreign exchange and foreign trade control laws.
- The information contained herein is presented only as a guide for the applications of our products. No responsibility is assumed by TOSHIBA CORPORATION for any infringements of intellectual property or other rights of the third parties which may result from its use. No license is granted by implication or otherwise under any intellectual property or other rights of TOSHIBA CORPORATION or others.
- The information contained herein is subject to change without notice.

EXPLANATION OF TERMINALS (Terminal voltage is DC voltage at $T_a = 25^\circ\text{C}$, $V_{CC} = 5\text{V}$, and no signal)

PIN No.	SYMBOL	INTERNAL	TERMINAL VOLTAGE (V)
1	FM-RF IN		0.8
2	BY PASS		1.5
3	FM-RF OUT		5.0
4	MIX IN		1.5
5	GND	—	0
6	MIX OUT	cf. pin ④	5.0
7	OSC MONITOR		4.3
8	OSC		5.0
9	V_{CC}	—	5.0

MAXIMUM RATINGS (Ta = 25°C)

CHARACTERISTIC	SYMBOL	RATING	UNIT
Supply Voltage	V _{CC}	8	V
Power Dissipation	P _D (Note)	500	mW
Operating Temperature	T _{opr}	-25~75	°C
Storage Temperature	T _{stg}	-55~150	°C

(Note) Derated above 25°C in the proportion of 4mW/°C.

ELECTRICAL CHARACTERISTICS (V_{CC} = 3V, f = 83MHz, f_m = 1kHz, Δf = ±22.5kHz, Ta = 25°C)

CHARACTERISTIC		SYMBOL	TEST CIR-CUIT	TEST CONDITION	MIN.	TYP.	MAX.	UNIT
Supply Current		I _{CC}	2	V _{in} = 0	—	5.2	8.0	mA
-3dB Limiting Sensitivity		V _{in} (lim)	2	—	—	3.0	7.0	dB _{μV} EMF
Quiescent Sensitivity		Q _S	2	—	—	11.0	—	dB _{μV} EMF
Conversion Gain		G _C	—	—	—	31	—	dB
Local OSC Voltage		V _{OSC}	1	f _{OSC} = 60MHz	90	165	220	mV _{rms}
Pin ① Impedance	Parallel Input Resistance	r _{ip1}	3	f = 83MHz	—	57	—	Ω
Pin ③ Impedance	Parallel Output Resistance	r _{op3}	3		—	25	—	kΩ
	Parallel Output Capacitance	c _{op3}			—	2.0	—	pF
Pin ④ Impedance	Parallel Input Resistance	r _{ip4}	3		—	2.7	—	kΩ
	Parallel Input Capacitance	c _{ip4}			—	3.3	—	pF
Pin ⑥ Impedance	Parallel Output Resistance	r _{op6}	3		f = 10.7MHz	—	100	—
	Parallel Output Capacitance	c _{op6}		—		4.8	—	pF
Local OSC Stop Voltage		V _{stop}	1	—	—	0.9	1.3	V

TEST CIRCUIT 3

Input output impedance

(1) r_{ip1} , C_{ip1}

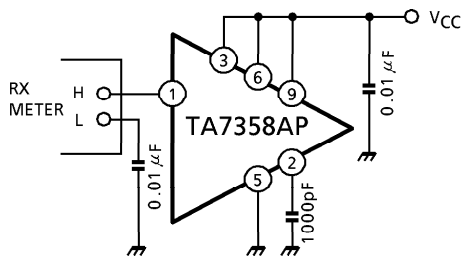

(2) r_{op3} , C_{op3}

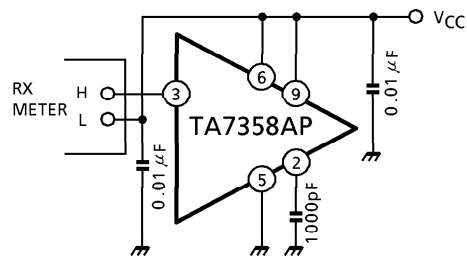

(3) r_{ip4} , C_{ip4}

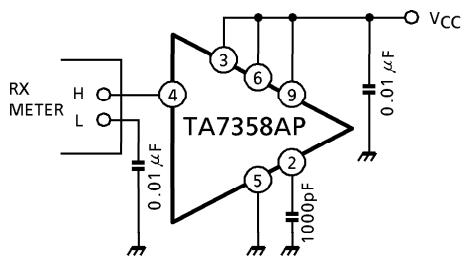

(4) r_{op6} , C_{op6}

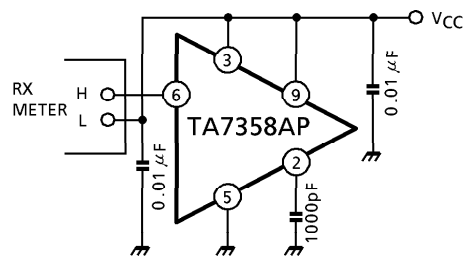

TEST CIRCUIT COIL DATA (Japan band for 76.0MHz to 108.0MHz)

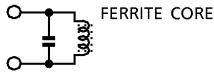
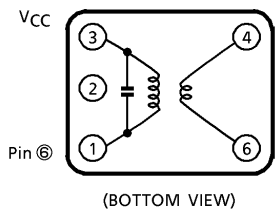
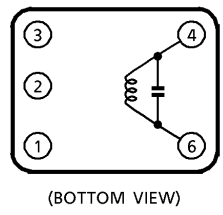
COIL	f_o	Q_o	TURNS	CAPACITANCE	
T ₁ RF Coil	100MHz	100	0.5mm ϕ 2 $\frac{1}{4}$ T Center Tap (Japan Band)	15pF (External)	 FERRITE CORE
T ₂ OSC Coil	100MHz	100	0.5mm ϕ 2 $\frac{1}{2}$ T (Japan Band)	15pF (External)	 FERRITE CORE
T ₃ IFT Coil	10.7MHz	115	①-③ 12T ④-⑥ 1T Wire 0.12mm ϕ UEW SUMIDA ELECTRIC Co., LTD. 5764 or equivalent	75pF	 (BOTTOM VIEW)
T ₄ Quad Coil	10.7MHz	150	④-⑥ 14T Wire 0.12mm ϕ UEW SUMIDA ELECTRIC Co., LTD. 44M-933A or equivalent	47pF	 (BOTTOM VIEW)

Band Pass Filter (BPF)

SOSHIN ELECTRIC Co., LTD. BPWB5

Tuning Capacitor

ALPS ELECTRIC Co., LTD. CB41EL933

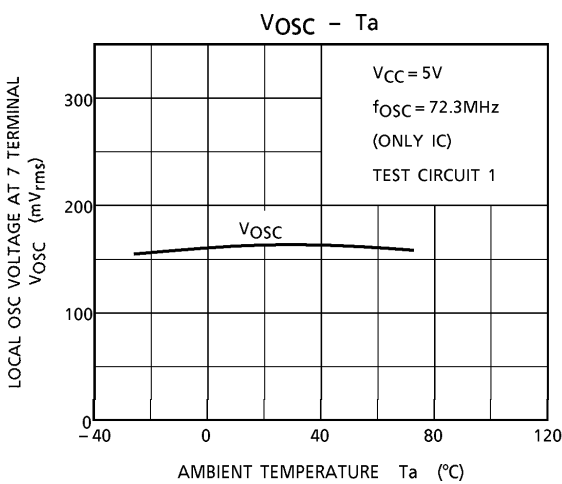
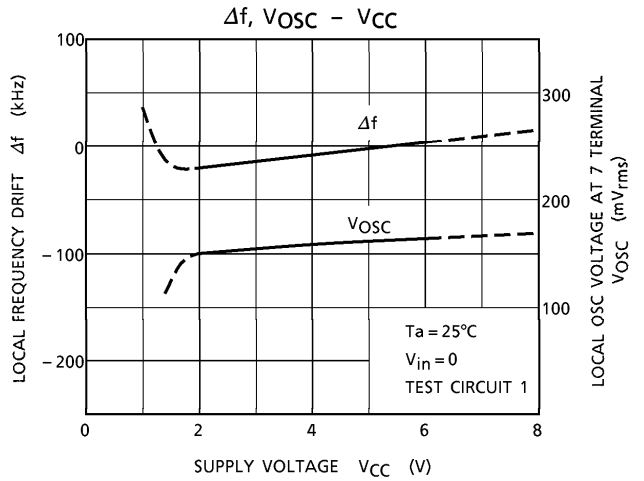
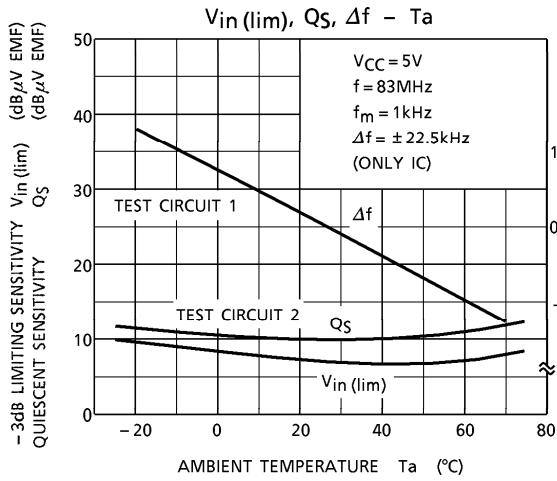
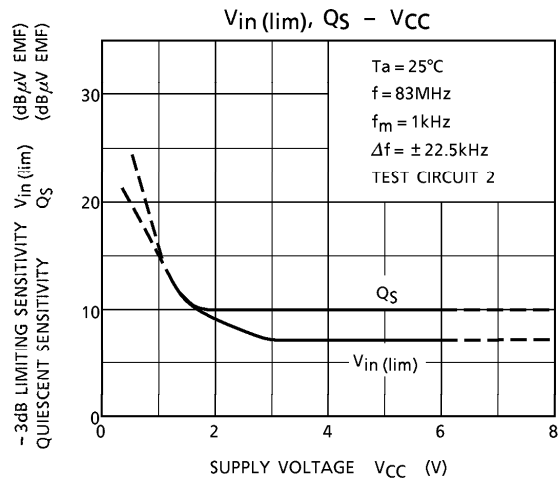
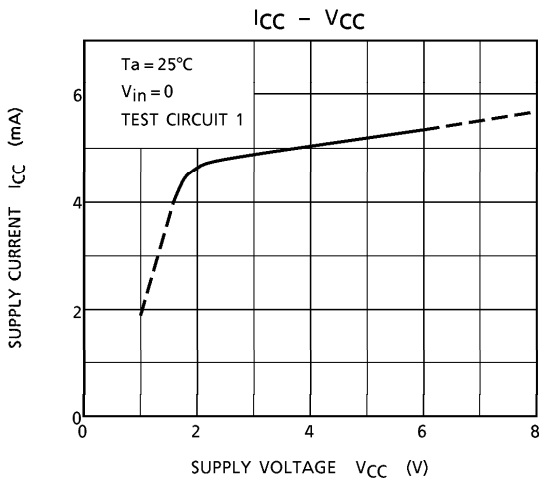

OUTLINE DRAWING
SIP9-P-2.54A

Unit : mm

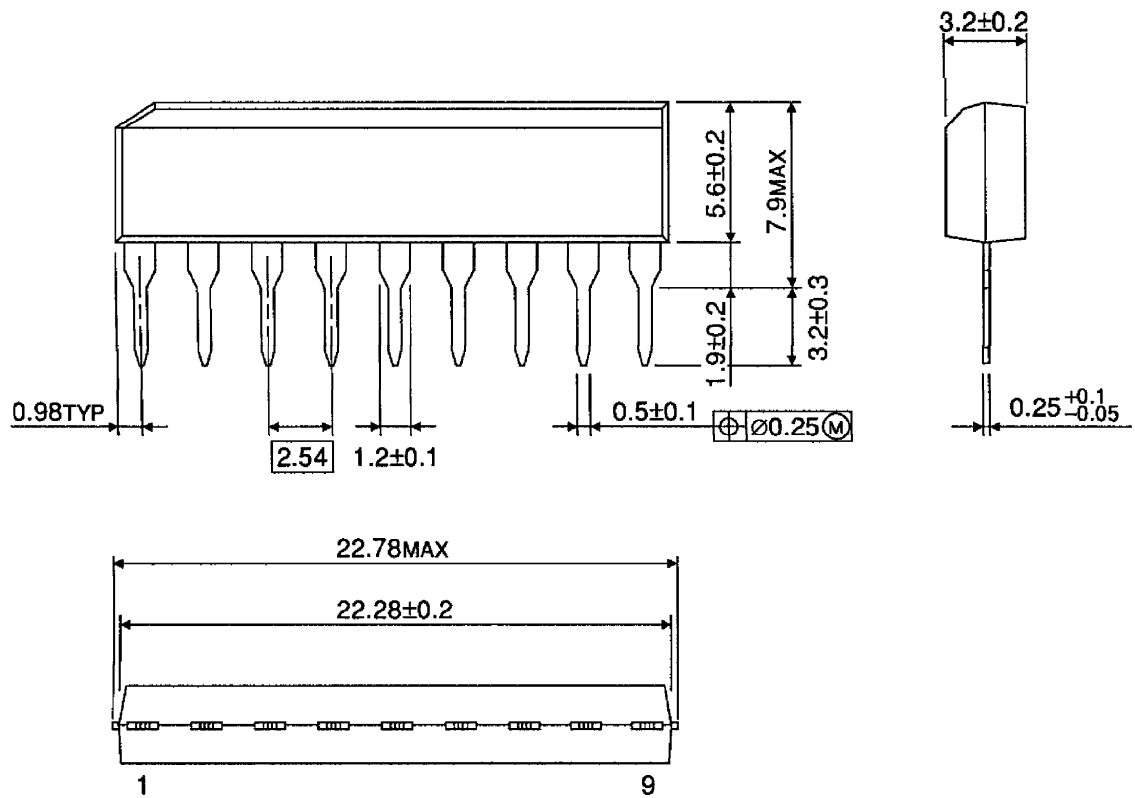

Weight : 0.92g (Typ.)